

Thunderbolt Versions

Version	Bandwidth	Connector Type
1	10 Gbps	Mini Displayport
2	20 Gbps	Mini Displayport
3	40 Gbps	USB Type-C
4	40 Gbps	USB Type-C

USB Versions

USB Version	Name	Transfer Rate
USB 1.0	Low-Speed	1.5 Mbps
USB 1.1	Full-Speed	12 Mbps
USB 2.0	Hi-Speed	480 Mbps
USB 3.0	SuperSpeed	5 Gbps
USB 3.1	SuperSpeed+	10 Gbps
USB 3.2	SuperSpeed+	10/20 Gbps

Reserved IP Ranges

Name	Start	End
RFC1918 (Private)	10.0.0.0/8	10.255.255.255/8
RFC1918 (Private)	172.16.0.0/16	172.31.255.255/16
RFC1918 (Private)	192.168.0.0/24	192.168.255.255/24
Localhost	127.0.0.0/8	127.255.255.255/8
APIPA (Link Local)	164.254.0.0/16	169.254.255.255/16

Classful IP Ranges

Class	Start	End
A	0.0.0.0	127.255.255.255
B	128.0.0.0	191.255.255.255
C	192.0.0.0	223.255.255.255
D	224.0.0.0	239.255.255.255
E	240.0.0.0	255.255.255.255

Laser Printing Process

Step	Name	Description
1	Processing	Build image in memory
2	Charging	Negatively charge drum
3	Exposing	Write image on drum with laser
4	Developing	Apply toner to charged drum
5	Transferring	Move toner from drum to paper
6	Fusing	Heat and bake toner to page
7	Cleaning	Clean excess toner from drum

Storage Interfaces

Interface	Throughput
Sata 3	6 Gbps
NVME	16 Gb/s PCIe 3x4
NVME	32 Gb/s PCIe 4x4
SAS	12-45 Gbps

DDR Memory Pins

Standard	DIMM Pin Count	SODIMM Pin Count
DDR	184	200
DDR2	240	200
DDR3	240	204
DDR4	288	260
DDR5	288	260

Common Resolution

Common Name	Resolution	Aspect Ratio
SVGA	800x600 Pixels	4:3
XGA	1024x768 Pixels	4:3
Super XGA	1280x960 Pixels	4:3
HD	1280x720 Pixels	16:9
Full HD	1920x1080 Pixels	16:9
2K or 1440p	2560x1440 Pixels	16:9
Ultra HD or 4K	3840x2160 Pixels	16:9



By ChymyHendrix

Not published yet.

Last updated 5th December, 2022.

Page 1 of 6.

Sponsored by [Readable.com](https://readable.com)

Measure your website readability!

<https://readable.com>

Common RAID

RAID #	Common Name	Minimum # of Disks	Fault Tolerance
RAID 0	Disk Striping	2	None
RAID 1	Disk Mirroring	2	1 Drive
RAID 5	Striping with Parity	3	1 Drive
RAID 10	Mirrored Stripe with Parity	4	1 Per subsystem

Useful Shortcuts

Shortcut	Description
Ctrl + [C, V, X]	Copy, Paste, Cut
Win + V	Paste Using Clipboard History
Win + Tab	Cycle Between Windows
Ctrl + Shift + Esc	Open Task Manager
Ctrl + Win + Q	Open Quick Assist
Win + P	Multi-Display Options
Win + E	Open File Explorer

Logging Levels

Level	Name	Description
0	Emergencies	Device Unusable
1	Alerts	Immediate Action
2	Critical	Critical Conditions
3	Errors	Error Condition
4	Warnings	Warning Condition
5	Notification	Normal but Important
6	Informational	Info Message
7	Debugging	Debug Message

Intel Processor Suffixes

Suffix	Meaning
K	Unlocked Frequency
S	Special Edition
T	Power-Optimized
F	No Integrated Graphics
U	Mobile Power Efficient
HK	High Performance Mobile, Unlocked
HQ	High Performance Mobile, Quad Core
X/XE	High Performance, Unlocked
E	Embedded

AMD CPU Suffixes

Suffix	Meaning
X	High Performance
G	Standard Desktop with Graphics
T	Low Power Desktop
S	Low Power Desktop with Graphics
H	High Performance Mobile
U	Standard Mobile
M	Low Performance Mobile
None	Standard Desktop

Intel Core CPU Code Names

Generation	Codename	Socket
1st	Nehalem	LGA 1156 / 1366
2nd	Sandy Bridge	LGA 1155 / 2011
3rd	Ivy Bridge	LGA 1155 / 2011
4th	Haswell	LGA 1150 / 2011
5th	Broadwell	LGA 1150 / 2011
6th	Skylake	LGA 1151 / 2066
7th	Kaby Lake	LGA 1151 / 2066
8th & 9th	Coffee Lake	LGA 1151
10th	Comet Lake, Ice Lake	LGA 1200
11th	Rocket Lake, Tiger Lake	LGA 1200



By ChymyHendrix

Not published yet.

Last updated 5th December, 2022.

Page 2 of 6.

Sponsored by [Readable.com](https://readable.com)

Measure your website readability!

<https://readable.com>

Intel Core CPU Code Names (cont)

12th	Alder Lake	LGA 1700
13th	Raptor Lake	LGA 1700

MacOS Release Names

Release	Name	Release Year
10	Cheetah	2001
10.1	Puma	2001
10.2	Jaguar	2002
10.3	Panther	2003
10.4	Tiger	2005
10.5	Leopard	2007
10.6	Snow Leopard	2009
10.7	Lion	2011
10.8	Mountain Lion	2012
10.9	Mavericks	2013
10.10	Yosemite	2014
10.11	El Capitan	2015
10.12	Sierra	2016
10.13	High Sierra	2017
10.14	Mojave	2018
10.15	Catalina	2019
11	Big Sur	2020
12	Monteray	2021
13	Ventura	2022

M.2 Sizes

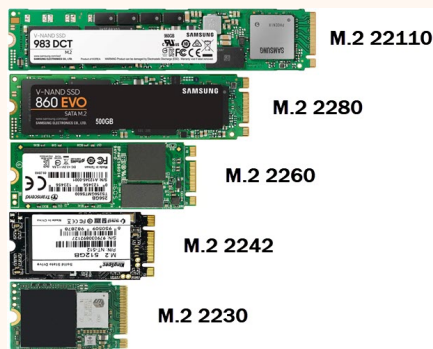

Windows Versions

Major Windows Versions	Release Year	Windows Server Versions
Windows 1.0	1985	Windows Server 2000
Windows 2.0	1987	Windows Server 2003
Windows 3.0	1990	Windows Server 2008
Windows 95	1995	Windows Server 2012
Windows 98	1998	Windows Server 2016
Windows 2000	2000	Windows Server 2019
Windows ME	2000	Windows Server 2022
Windows XP / Professional	2001 / 2005	
Windows Vista	2007	
Windows 7	2009	
Windows 8 / 8.1	2012 / 2013	
Windows 10	2015	
Windows 11	2021	

M.2 Connectors

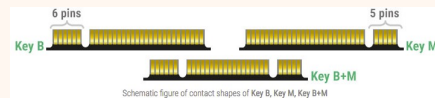

PCIe Details

PCIe Slot Width	Number of Pins	Version	X16 Transfer Rate
X1	18	PCIe 1.0	250 MB/s
x4	21	PCIe 2.0	500 MB/s
x8	49	PCIe 3.0	984 MB/s
x16	82	PCIe 4.0	1969 MB/s
		PCIe 5.0	3938 MB/s



By ChymyHendrix

Not published yet.

Last updated 5th December, 2022.

Page 3 of 6.

Sponsored by [Readable.com](https://readable.com)

Measure your website readability!

<https://readable.com>

UPT Categories and Speeds

Category	Speed	Bandwidth
Cat 5	100 Mbps @ 100m	100 MHz
Cat 5e	100 Mbps @ 100m	100 MHz
Cat 5e	1 Gbps @ 100m	350 MHz
Cat 6	1 Gbps @ 100m	250 MHz
Cat 6	10 Gbps @ 37m	250 MHz
Cat 6a	10 Gbps @ 100m	500 MHz
Cat 7	10 Gbps @ 100m	600 MHz
Cat 7a	10 Gbps @ 100m	1000 MHz
Cat 7a	40 Gbps @ 50m	1000 MHz
Cat 8.1	25 Gbps @ 30m	2000 MHz
Cat 8.2	40 Gbps @ 30m	2000 MHz

Ethernet Wiring Guide

Pin	Signal	T568A	T568B
1	TX+	White/Green	White/Orange
2	TX-	Green	Orange
3	RX+	White/Orange	White/Green
4	TRD2+	Blue	Blue
5	TRD2-	White/Blue	White/Blue
6	RX-	Orange	Green
7	TRS3+	White/Brown	White/Brown
8	TRS3-	Brown	Brown

Ethernet Wiring Diagram

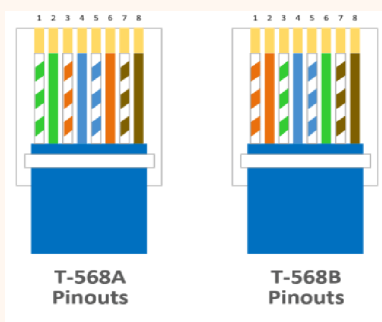

24 Pin ATX Power

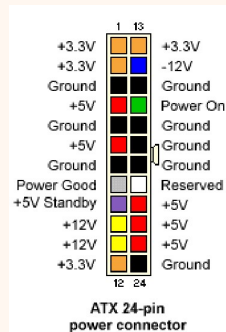

20 Pin ATX Power

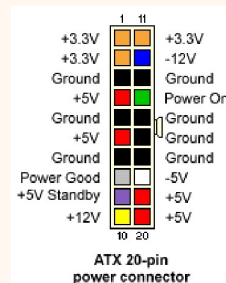

PCIe Power Pinout

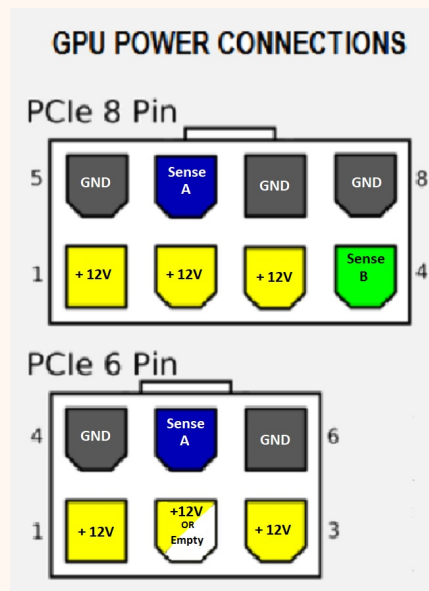

By ChymyHendrix

Not published yet.
Last updated 5th December, 2022.
Page 4 of 6.

Sponsored by [Readable.com](https://readable.com)
Measure your website readability!
<https://readable.com>

Peripheral Power

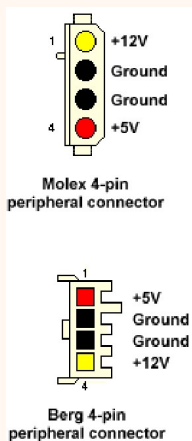

More USB Pinouts

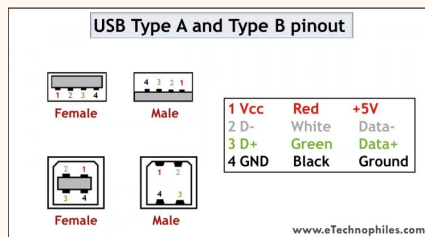

PCIe Slot Size

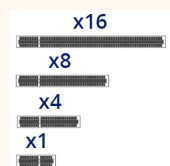

SATA Pinout

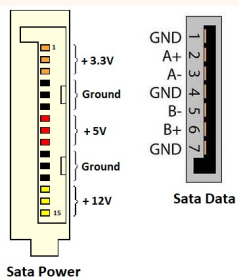

4 Pin CPU Power

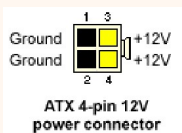

USB Pinouts

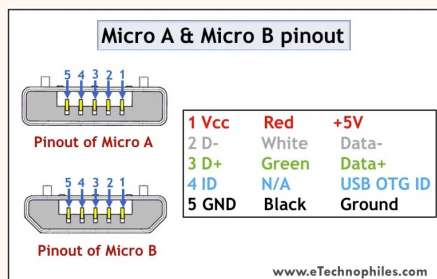

NVIDIA GPUs

Series	Popular Models	Release Year
400 Series	GTX 470, 480	2010/2011
600 Series	GTX 650, 670, 680	2012/2013
700 Series	GT 710, GTX 750, 780, TITAN	2013/2014
900 Series	GTX 960, 970, 980, TITAN X	2014/2015
10 Series	GTX 1050ti, 1060, 1070, 1080, TITAN V	2016/2017
16 Series	GTX 1650, 1660 / Super	2019
20 Series	RTX 2060, 2070, 2080, TITAN RTX	2018/2019
30 Series	RTX 3060/TI, 3070, 3080, 3090	2020/2021
40 Series	RTX 4080, RTX 4090	2022



By ChymyHendrix

Not published yet.

Last updated 5th December, 2022.

Page 5 of 6.

Sponsored by [Readable.com](https://readable.com)

Measure your website readability!

<https://readable.com>

AMD GPUs

Series	Popular Models	Release Year
Radeon 400	R5/7 430, RX 470, 480	2016
Radeon 500	RX 570, 580, 590	2017
RX Vega Series	Vega 56, 64	2017
Radeon VII	Radeon VII	2019
RX 5000	RX 5500, 5700, 5700XT	2019
RX 6000	RX 6600/6650, 6800/XT, 6900/XT	2021/2022
RX 7000	RX 7900 XT, 7900 XTX	2022



By ChymyHendrix

cheatography.com/chymyhendrix/

Not published yet.

Last updated 5th December, 2022.

Page 6 of 6.

Sponsored by **Readable.com**

Measure your website readability!

<https://readable.com>